

BULKHEAD STRAIGHT MALE JACK
FULL DETENT SOLDER TYPE CABLE .047

R222.301.002

Series : SMP

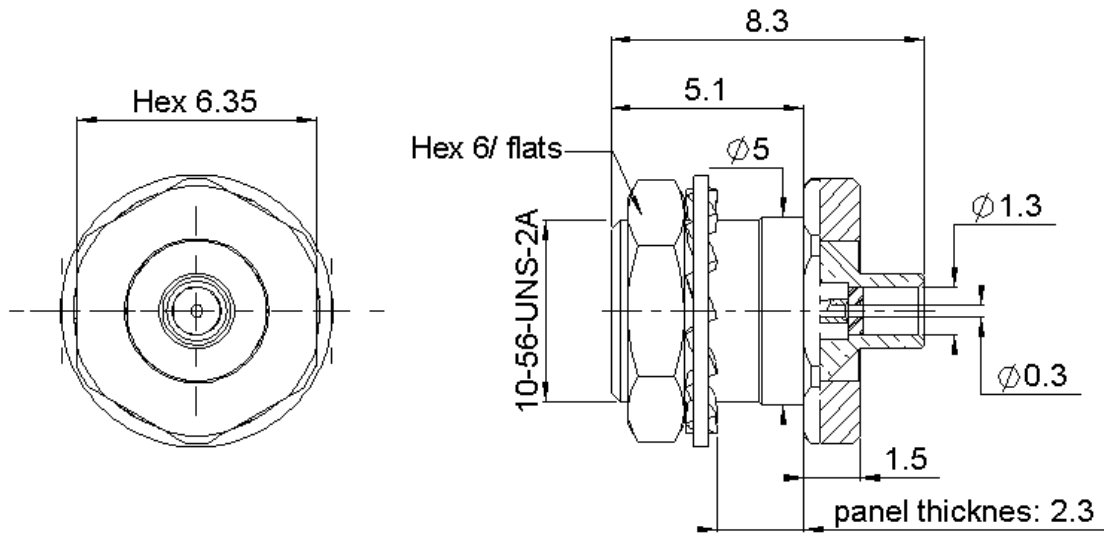

PANEL CUT OUT

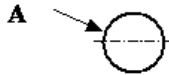

	mm	
	Maxi	mini
A	5.30	5.20

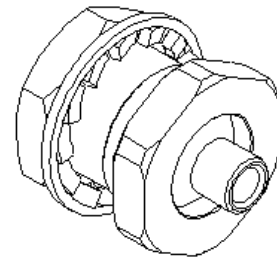
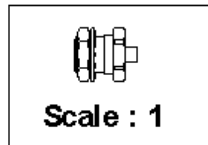

All dimensions are in mm.

COMPONENTS	MATERIALS	PLATINGS (µm)
BODY	STAINLESS STEEL + BRASS	PASSIVATED + GOLD1.3 OVER NICKEL2
CENTER CONTACT	BERYLLIUM COPPER	GOLD 1.27 OVER NICKEL 1.27
OUTER CONTACT		
INSULATOR	PTFE	
GASKET		
OTHERS PARTS	BRASS	NICKEL .
-	-	-
-	-	-

Issue : 0529 B

In the effort to improve our products, we reserve the right to make changes judged to be necessary.



BULKHEAD STRAIGHT MALE JACK
FULL DETENT SOLDER TYPE CABLE .047

R222.301.002

Series : SMP

PACKAGING

Standard	Unit	Other
100	'W' option	Contact us

SPECIFICATION

ELECTRICAL CHARACTERISTICS

Impedance		50 Ω
Frequency		0-40 GHz
VSWR	1.50 +	0.000 x F(GHz) Maxi
Insertion loss		0.12 √F(GHz) dB Maxi
RF leakage	- (* - F(GHz)) dB Maxi
Voltage rating		335 Veff Maxi
Dielectric withstanding voltage		500 Veff mini
Insulation resistance		5000 MΩ mini

CABLE ASSEMBLY

Stripping	a	b	c	d	e	f
mm	1.30	0.00	0.00	0.00	0.00	0.00

Assembly instruction :

Recommended cable(s)
 UT47 M17/151-00001

Characteristics indicated on this data sheet are those that can be achieved with the highest performance cable. Intrinsic limitations of the cable may diminish the performance of the assembly

Cable retention

- pull off	45 N mini
- torque	NA N.cm

MECHANICAL CHARACTERISTICS

Center contact retention		
Axial force – Mating end	NA	N mini
Axial force – Opposite end	NA	N mini
Torque	NA	N.cm mini

TOOLING

Part Number	Description	Hexagon
.	.	.
R282.740.030	SOLDERING MOUNTING	
R282.743.100	POSITIONER FOR SOLDERING SMP	
R282.744.254	POSITIONER FOR SOLDERING SMP	

Recommended torque		
Mating		N.cm
Panel nut	60	N.cm
Clamp nut		N.cm
A/F clamp nut	0.000	mm

Mating life	100	Cycles mini
Weight	1.146	g

OTHERS CHARACTERISTICS

*RF leakage -80dB DC-3 GHz
 -65dB 3-26.5 GHz
 Compliant with MIL-STD-348

ENVIRONMENTAL

Operating temperature	-65/+165	° C
Hermetic seal	NA	Atm.cm3/s
Panel leakage	NA	

Issue : 0529 B

In the effort to improve our products, we reserve the right to make changes judged to be necessary.



BULKHEAD STRAIGHT MALE JACK
FULL DETENT SOLDER TYPE CABLE .047

R222.301.002

Series : SMP

COMPONENTS

STRIPPING CABLES

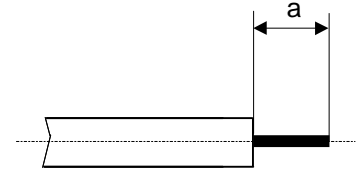
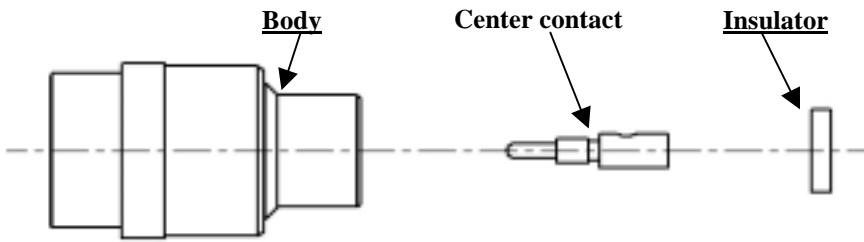

We recommend a thermal preconditioning cable

1

Strip the dielectric of the cable .
 Clean the cable .
 Soldering 180°C
 Temperature stoking do not exceeded 250°C

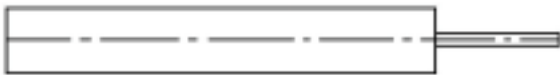

2

Screw the positoner onto the soldering jig.
 Slide the center contact onto the cable inner conductor
 against insulator.
 Fit the cable assembly onto the soldering jig.
 Insert the soldering gauge
 Tighten.
 Take off the soldering gauge.
 and solder the contact.

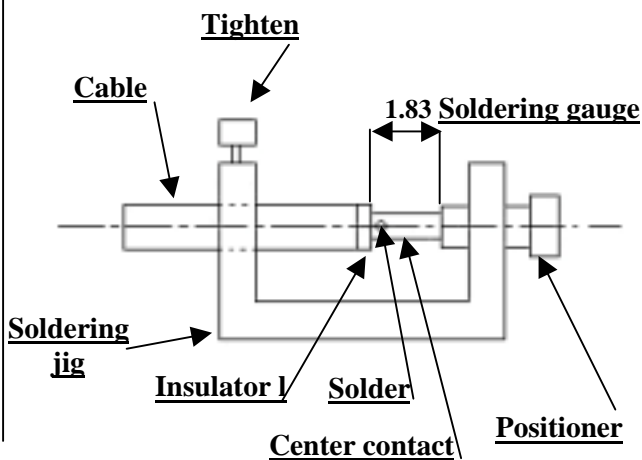

3

After cooling remove cable assembly from the jig.
 Insert cable+centre contact in the connector.
 Slide the positioner in the connector interface.
 Slide cable into the connector body until it bottoms
 against.
 Slide positoner into the assembly.
 Tighten.
 Solder the body onto the cable.
 After cooling remove cable assembly from the jig.

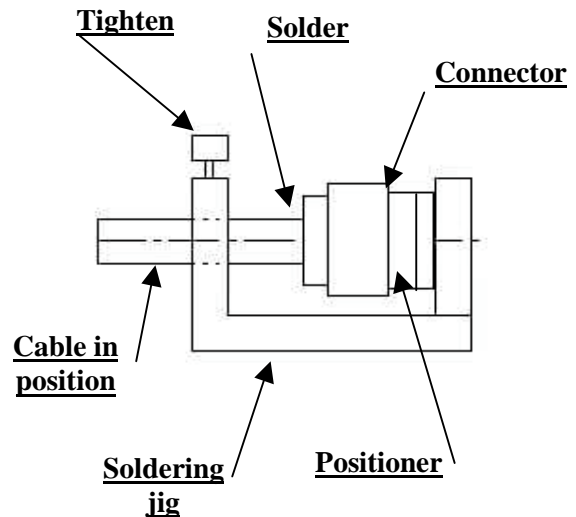

Issue : 0529 B

In the effort to improve our products, we reserve the right to make changes judged to be necessary.

